

Rubber buffers steel or stainless steel, type B

Item description/product images



Description

Material:

Metal parts steel grade 5.6 or stainless steel.
Elastomer natural rubber, medium hardness, Shore 55A.

Version:

Steel electro zinc-plated.
Stainless steel bright.

Note:

Rubber buffers are widely-used construction elements for elastic mounting. They are used, among other things, as mountings for aggregates, motors, compressors, pumps and testing machinery.

Temperature range:

-30°C to +80°C.

On request:

Other Shore grades.

Drawings

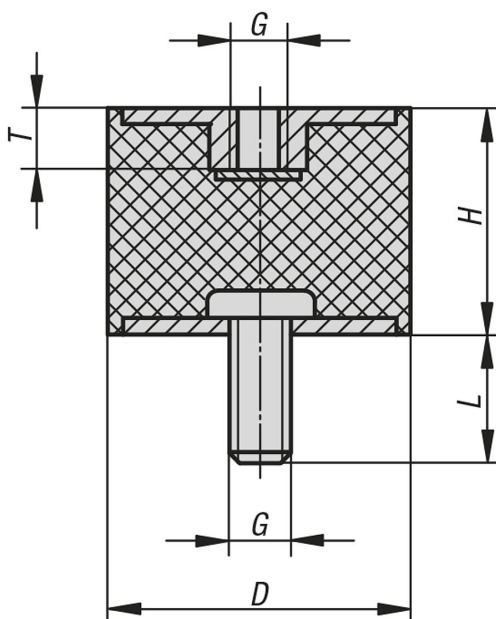

Overview of items

Rubber buffers, steel or stainless steel, type B

Order No.	Main material	D	H	G	L	T	Spring stiffness N/mm	Load N
K0568.00800855	steel	8	8	M3	6	3	35	17
K0568.01001055	steel	10	10	M4	10	4	75	75
K0568.01001555	steel	10	15	M4	10	4	50	60
K0568.01500855	steel	15	10	M4	10	4	130	130
K0568.01501555	steel	15	15	M4	10	4	100	120

Rubber buffers steel or stainless steel, type B

Overview of items

Order No.	Main material	D	H	G	L	T	Spring stiffness N/mm	Load N
K0568.02001555	steel	20	15	M6	18	6	325	390
K0568.02002055	steel	20	20	M6	18	6	130	260
K0568.02002555	steel	20	25	M6	18	6	95	210
K0568.02501555	steel	25	15	M6	18	6	333	399
K0568.02502055	steel	25	20	M6	18	6	195	410
K0568.02502555	steel	25	25	M6	18	6	117	257
K0568.02503055	steel	25	30	M6	18	6	100	300
K0568.03001555	steel	30	15	M8	23	8	590	708
K0568.03002055	steel	30	20	M8	23	8	280	560
K0568.03002555	steel	30	25	M8	23	8	180	396
K0568.03003055	steel	30	30	M8	23	8	168	504
K0568.03004055	steel	30	40	M8	23	8	88	308
K0568.04002055	steel	40	20	M8	23	8	700	840
K0568.04003055	steel	40	30	M8	23	8	273	820
K0568.04004055	steel	40	40	M8	23	8	189	660
K0568.05002055	steel	50	20	M10	28	10	1471	2500
K0568.05002555	steel	50	25	M10	28	10	630	1386
K0568.05003055	steel	50	30	M10	28	10	545	1635
K0568.05004055	steel	50	40	M10	28	10	310	1116
K0568.05005055	steel	50	50	M10	28	10	180	900
K0568.06004055	steel	60	40	M10	28	10	500	1750
K0568.07004555	steel	70	45	M10	28	10	600	2400
K0568.07502555	steel	75	25	M12	37	12	2440	3660
K0568.07504055	steel	75	40	M12	37	12	700	2450
K0568.07505055	steel	75	50	M12	37	12	520	2600
K0568.07505555	steel	75	55	M12	37	12	396	2178
K0568.008008551	stainless steel	8	8	M3	8	3	35	17
K0568.010010551	stainless steel	10	10	M4	10	4	75	75
K0568.015010551	stainless steel	15	10	M4	10	4	-	-
K0568.020020551	stainless steel	20	20	M6	18	6	130	260
K0568.025020551	stainless steel	25	20	M6	18	6	195	410
K0568.030020551	stainless steel	30	20	M8	23	8	280	560
K0568.040020551	stainless steel	40	20	M8	23	8	700	840