

1/4-18 NPT AIR INLET BOTH ENDS

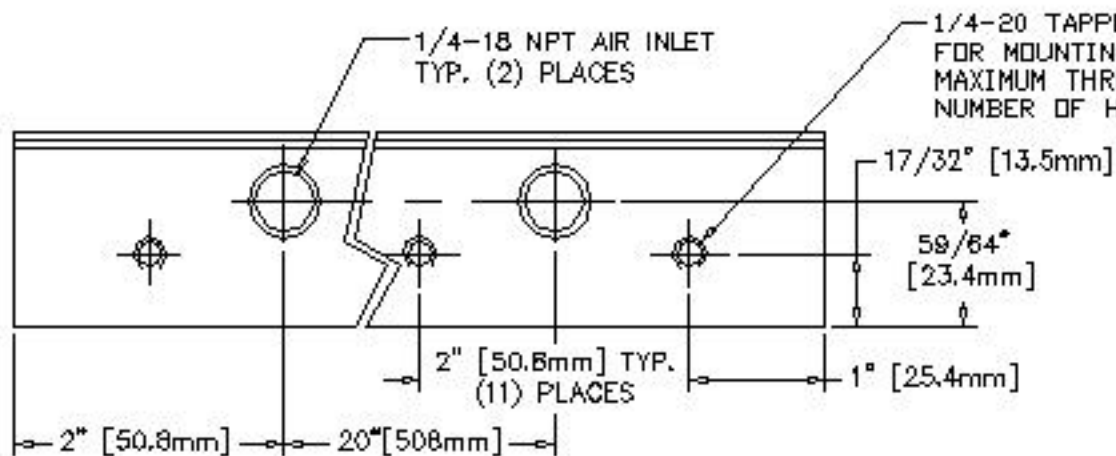
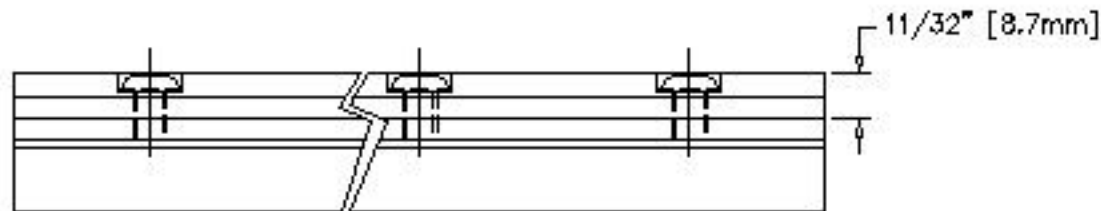

EXAIR CORPORATION

TITLE
24" SUPER ST.ST. AIR KNIFE

DATE	DRAWING NUMBER	SCALE
3/29/01	DIM-110024SS	1:1

COPYRIGHT 2001 - EXAIR CORPORATION