

# Horizontal Toggle Clamp

Part No. GH-20752-BSS

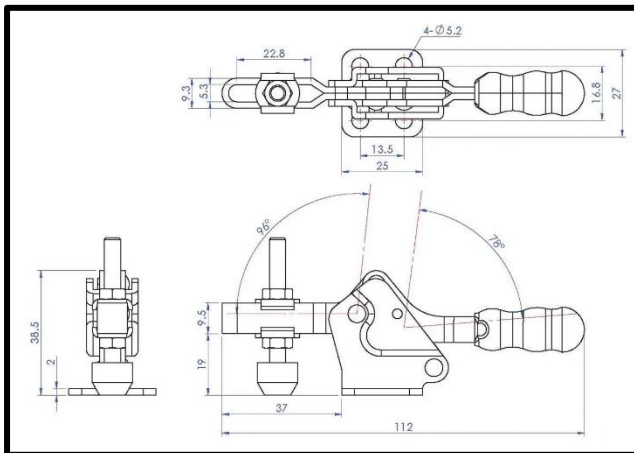
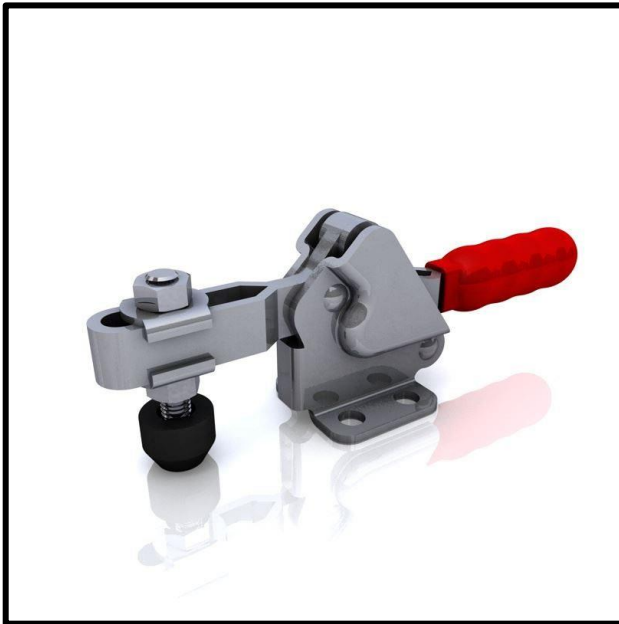

## Product Description

Stainless Steel Horizontal Clamp  
Flat Base Size 75daN

## Key Features

Overall Height:	38.5mm
Arm Length:	37mm
Underarm Height:	19mm
Holding Force:	75daN

## Other Features

Arm Opens:	96°
Handle Opens:	78°
Weight:	0.91Kg

## Material

Toggle Clamp:	304 Stainless Steel
Handle:	uPVC
Spindle:	304 Stainless Steel
Flanged Washers:	304 Stainless Steel
Cap:	Neoprene

## Whats In The Bag?

Toggle Clamp:	GH-20752-BSS
Spindle:	SA-054008-SS
Flanged Washers:	FW-100-SS
Cap:	NC-05



[goodhanduk.co.uk](http://goodhanduk.co.uk)

01908 221 151