

T-grips

Item description/product images

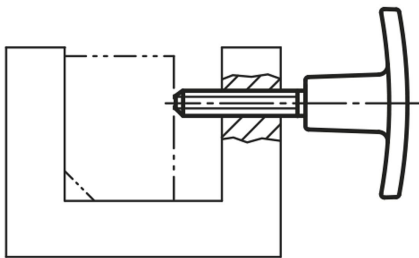

Description

Material:

Fibreglass reinforced thermoplastic.
Tapped bush brass.
Screw steel.

Version:

Grip, black.
Screw electro zinc-plated.

On request:

Grip colour red, yellow, green, blue, white or grey (min. quantity 500).

Drawings

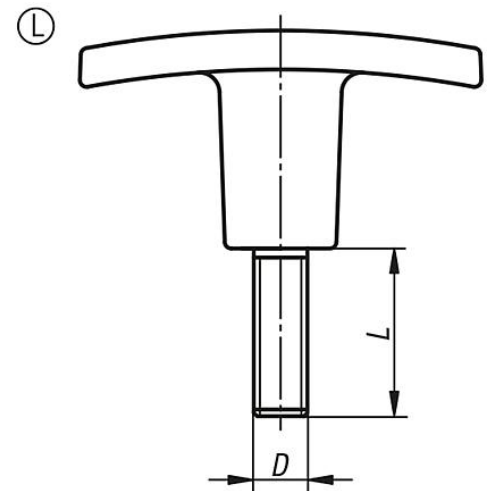
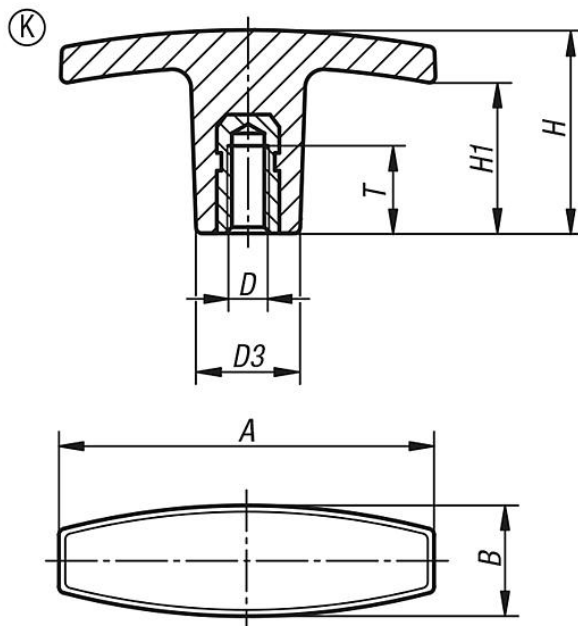

Overview of items

T-grips

Order No.	Form	A	B	D	D3	H	H1	L	T
K0180.14005	K	40	13	M5	13	30,5	20	-	10
K0180.15005	K	50	15	M5	14	24	16	-	10
K0180.16006	K	60	17	M6	16	31,5	23	-	12
K0180.17108	K	71	19,5	M8	20	36	19	-	20
K0180.17110	K	71	19,5	M10	20	36	19	-	20
K0180.18010	K	80	26	M10	26	39,5	26	-	25

T-grips

Overview of items

Order No.	Form	A	B	D	D3	H	H1	L	T
K0180.18012	K	80	26	M12	26	39,5	26	-	25
K0180.24005X15	L	40	13	M5	13	30,5	20	15	-
K0180.25005X15	L	50	15	M5	14	24	16	15	-
K0180.25005X20	L	50	15	M5	14	24	16	20	-
K0180.26006X20	L	60	17	M6	16	31,5	23	20	-
K0180.26006X25	L	60	17	M6	16	31,5	23	25	-
K0180.27108X20	L	71	19,5	M8	20	36	19	20	-
K0180.27108X30	L	71	19,5	M8	20	36	19	30	-
K0180.27110X20	L	71	19,5	M10	20	36	19	20	-
K0180.27110X30	L	71	19,5	M10	20	36	19	30	-
K0180.28010X30	L	80	26	M10	26	39,5	26	30	-
K0180.28012X40	L	80	26	M12	26	39,5	26	40	-