

Latches For Use with Padlocks Part No. CS-0210



Product Description

Latch With Catch Plate For Padlock Stainless Steel L=82-89mm

Key Features

Overall Length: 82-89mm
Load Capacity: 65daN

Other Features

Weight: 0.051Kg

Material

Toggle Latch: Stainless Steel

What's In The Bag?

Toggle Latch: CS-0210
Latch Plate: CS-0210-2

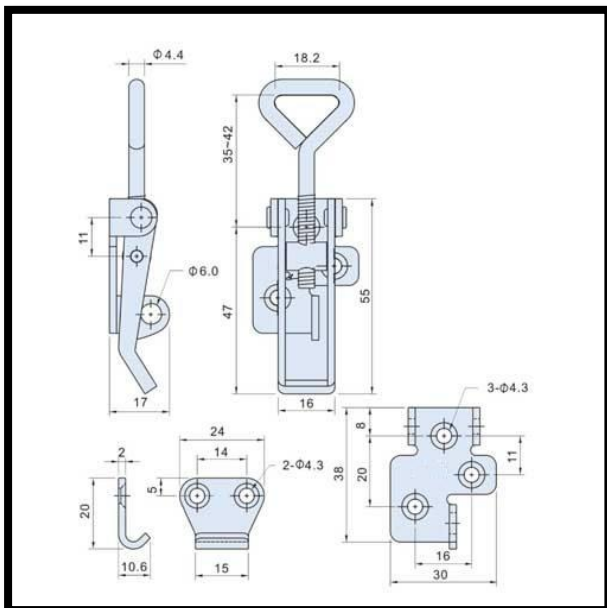

goodhanduk.co.uk

01908 221 151