

Case Latch
Part No. C-66

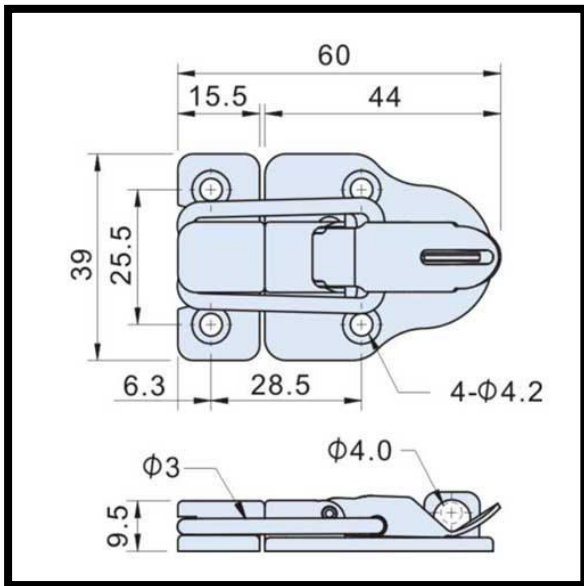

Product Description

Case Toggle Latch For Padlock Nickel Plated
L=60mm

Key Features

Overall Length: 60mm
Load Capacity: 20daN

Other Features

Weight: 0.029Kg

Material

Toggle Latch: Nickel Plated Steel

What's In The Bag?

Toggle Latch: C-66
Latch Plate: