

Vertical Toggle Clamp

Part No. GH-13007

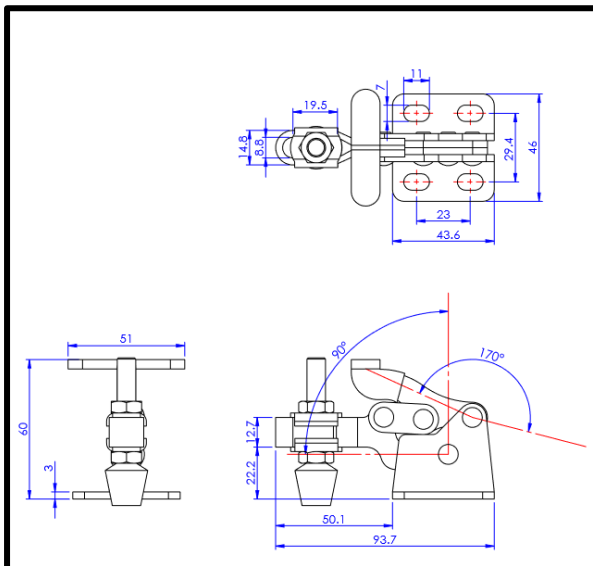
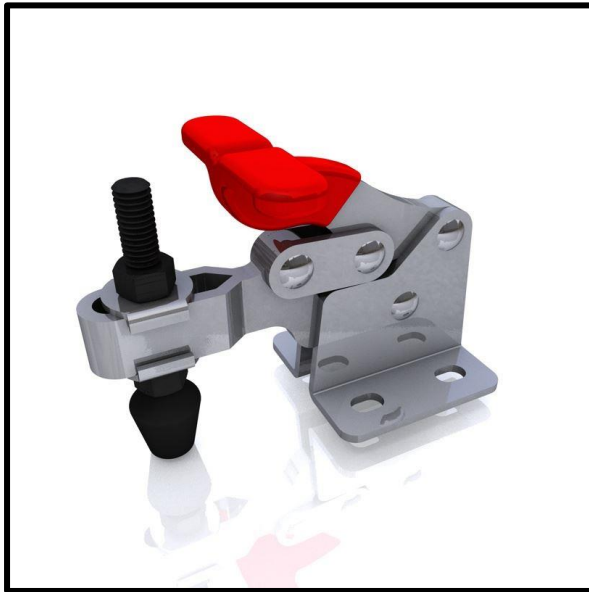

Product Description

Vertical Clamp Low Profile Flat
Base Slotted Arm Size 150Kg

Key Features

Overall Height: 60mm
Underarm Height: 22.2mm
Arm Length: 50.1mm
Holding Force: 150Kg

Other Features

Arm Opens: 90°
Handle Opens: 170°
Weight: 0.255Kg

Material

Clamp: Zinc Plated Mild Steel
Spindle: Neoprene Tipped Steel
Handle: uPVC

What's In The Bag?

GH-13007: Toggle Clamp
FC-086312: M8x63mm Neoprene Tipped
Steel Spindle With Nuts
2x FW-516: Flanged Washers For M8 Spindle



goodhanduk.co.uk

01908 221 151