

# Spring Toggle Latches Part No. CT-22



## Product Description

Spring Toggle Latch With Catch Plate Zinc Plated L=98mm

## Key Features

Overall Length: 98mm  
Load Capacity: 25daN

## Other Features

Weight: 0.042Kg

## Material

Toggle Latch: Zinc Plated Steel

## What's In The Bag?

Toggle Latch: CT-22  
Latch Plate: CT-22-2

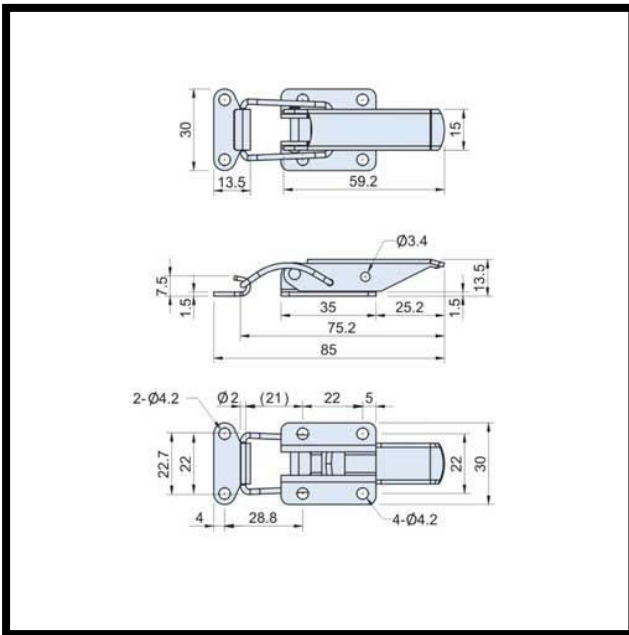

[goodhanduk.co.uk](http://goodhanduk.co.uk)

01908 221 151