

Vertical Toggle Clamp

Part No. GH-12131



Product Description

Vertical Clamp Low Profile Flat
Base Slotted Arm Size 227Kg

Key Features

Overall Height: 106mm
Underarm Height: 31.8mm
Arm Length: 73.2mm
Holding Force: 227Kg

Other Features

Arm Opens: 100°
Handle Opens: 56°
Weight: 0.38Kg

Material

Clamp: Zinc Plated Mild Steel
Spindle: Neoprene Tipped Steel
Handle: uPVC

What's In The Bag?

GH-12131: Toggle Clamp
FC-086312: M8x63mm Neoprene Tipped
Steel Spindle With Nuts
2x FW-516: Flanged Washers For M8 Spindle

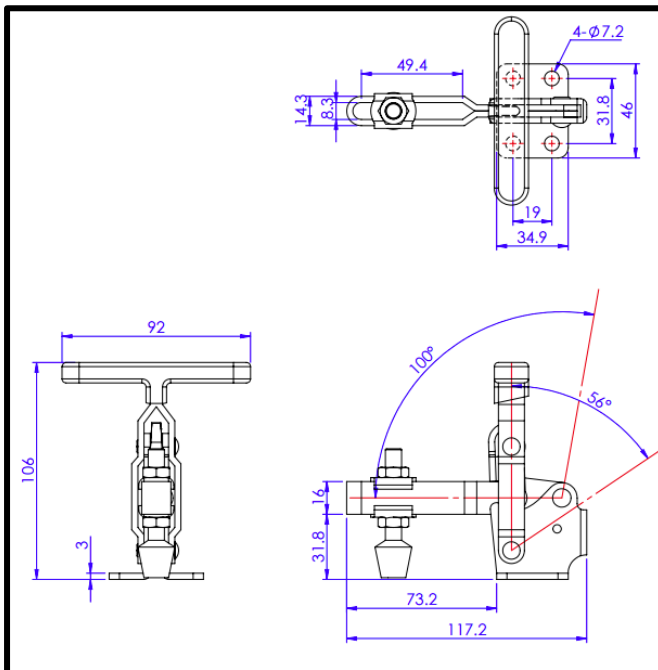

goodhanduk.co.uk

01908 221 151