

► Toggle Pliers

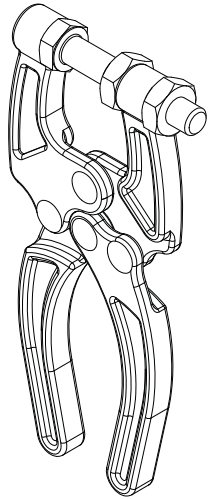

Part No: GH-50350
Holding Force: 90Kg
Weight: 0.19Kg
Spindle Supplied: SA-14112

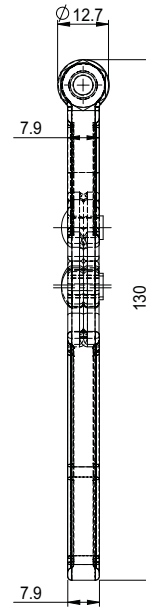
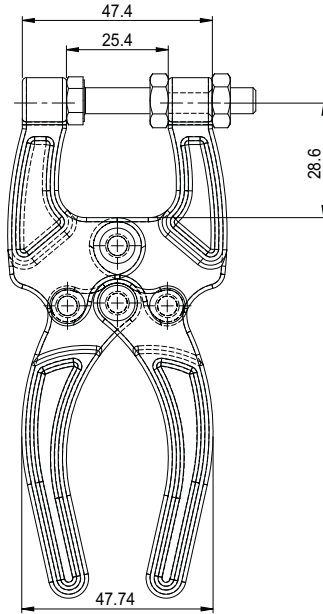
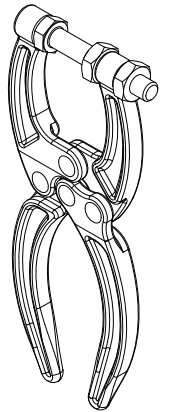
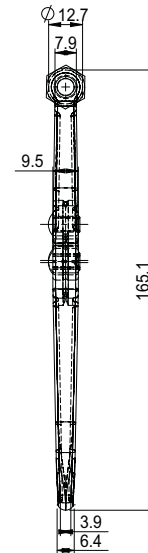
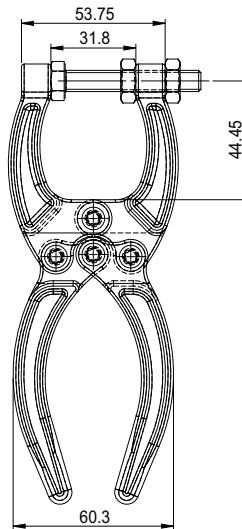

Part No: GH-50360
Holding Force: 160Kg
Weight: 0.29Kg
Spindle Supplied: SA-56200

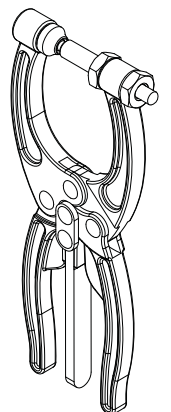
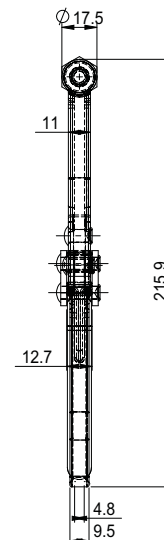
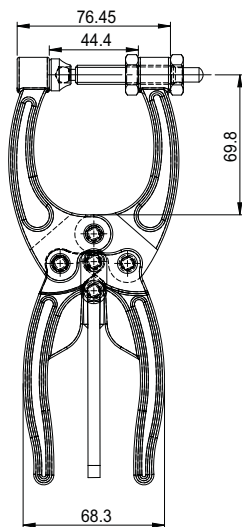

Part No: GH-50380
Holding Force: 320Kg
Weight: 0.66Kg
Spindle Supplied: SF-38300



► Toggle Pliers

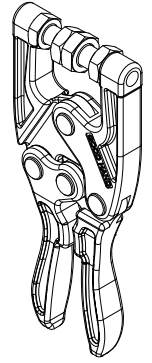
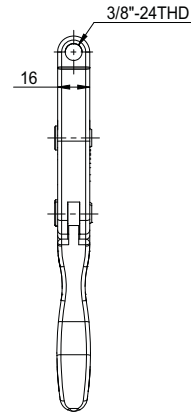
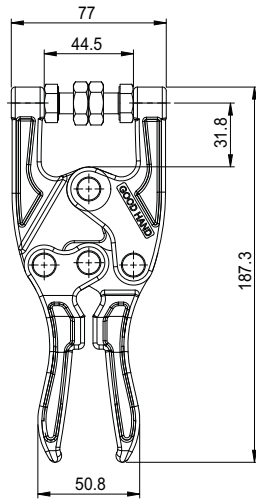

Part No:	GH-50385	
Holding Force:	820Kg	
Weight:	0.71Kg	
Spindle Supplied:	SA-38114	

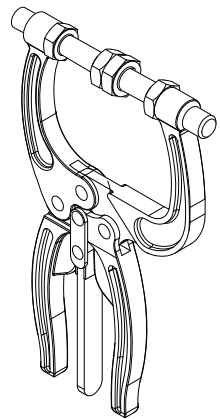
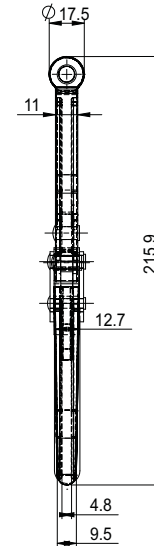
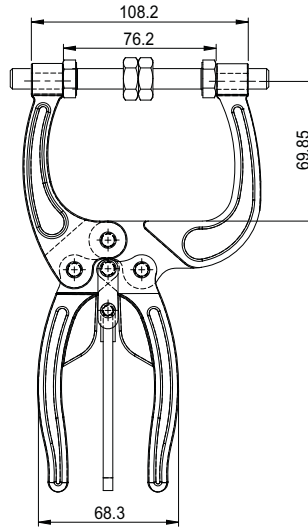

Part No:	GH-50450	
Holding Force:	320Kg	500Kg
Weight:	0.74Kg	0.60Kg
Spindle Supplied:	1 SF-38300 & 1 SA-38300	

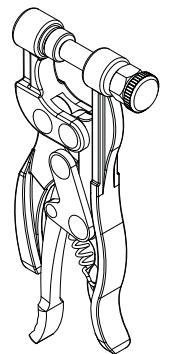
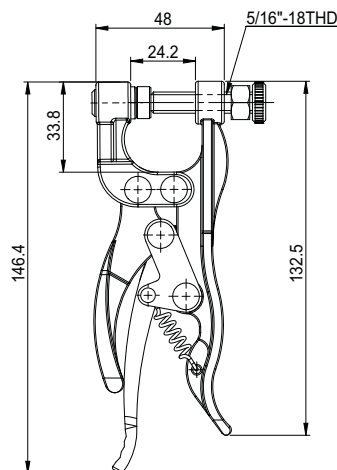

Part No:	GH-51000	
Holding Force:	200Kg	
Weight:	0.26Kg	
Spindle Supplied:	SA-56112	

